

32

HC32F460

MCU

F	HC32F460	
----------	-----------------	--

- HC32F460PETB

1.	4
1.1	4
1.2	4
2.	6
2.1	6
2.2	6
2.2.1	6
2.2.2	6
2.2.3	6
2.2.4	6
2.2.5	7
2.2.6	7
2.2.7	7
2.2.8	8
2.2.9	UART	8
2.2.10	I2C.....	8
2.2.11	SPI.....	8
2.2.12	QSPI	9
2.2.13	TF CARD	9
2.2.14	SMART CARD	9
2.2.15	USB	9
2.2.16	CAN	10
2.2.17	AUDIO	10
2.2.18	OLED	10
2.2.19	10
2.2.20	10
3.	12
3.1	-DDL.....	13
3.2	-help	13
3.3	-Template	13
4.	15
4.1	15
4.2	17

5. & 19

1.

1.1

Evaluation Board EVB HC32F460PETB-LQFP100
 USB-UART EVB HC32F460

1.2

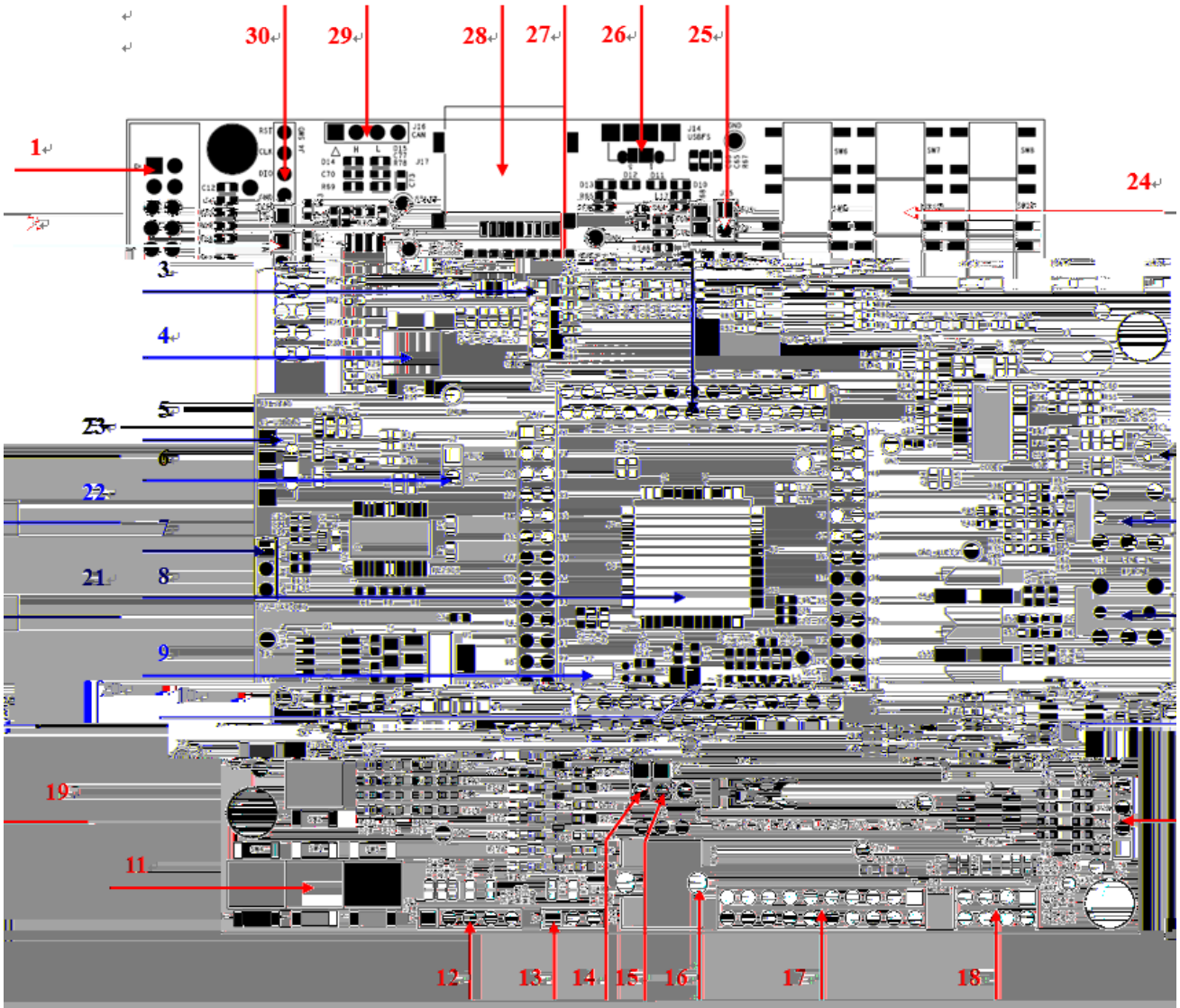

1	JTAG	2	
3	OLED	4	
5	Micro-USB (USB-UART)	6	5V0 (USB-UART)
7	UART3	8	HC32F460PETB
9	32.768KHz	10	8MHz
11	*4	12	SPI
13	UART4	14	
15	ADC	16	
17		18	UART2/SMART CARD
19	I2C	20	
21		22	LINE IN
23		24	
25	5V0 (USBFS)	26	Micro-USB (USBFS)
27	MCU *4	28	TF
29	CAN	30	SWD

2.

2.1

MCU (1.8-3.6V) -40-105

2.2

2.2.1

EVB

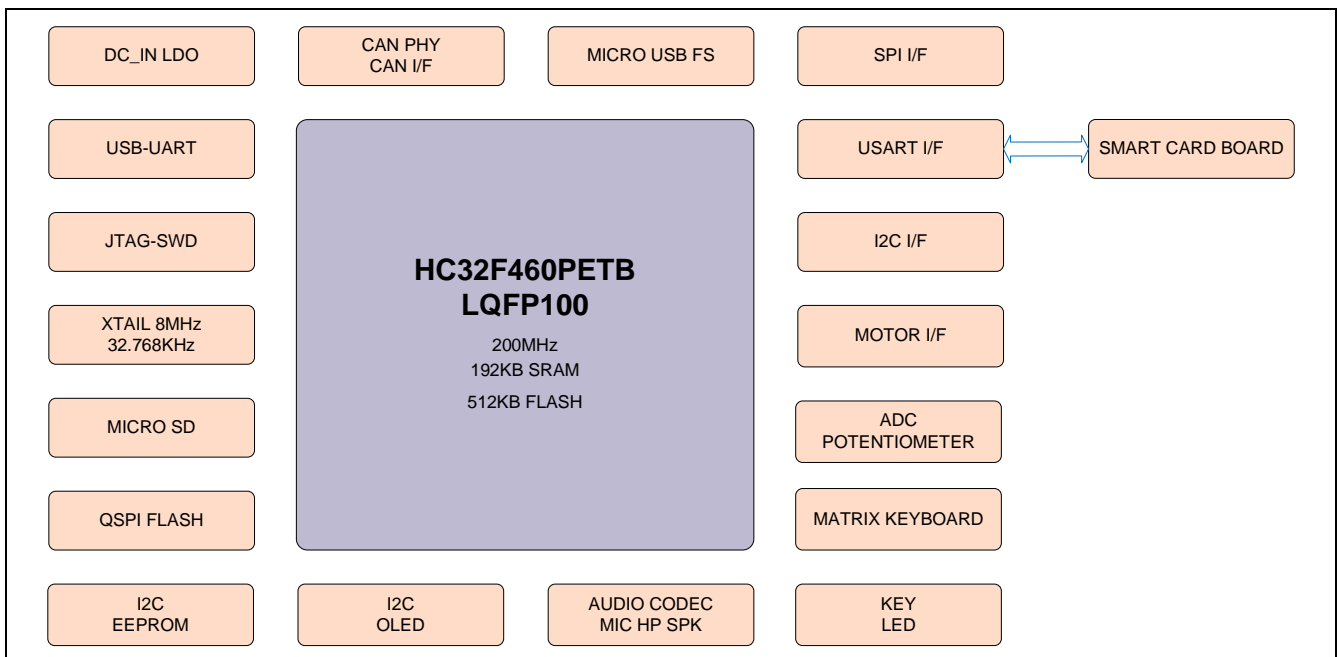

2.2.2

EVB MICRO USB USB

2.2.3

EVB SWD JTAG

2.2.4

EVB 5 1 4 MCU GPIO MCU

专	/
SW1	RESET/
SW2	PD3/
SW3	PD4/
SW4	PD5/
SW5	PD6/

2.2.5

EVB 5

MCU GPIO

专	/
D1	3V3
D23	PE6/
D26	PA7/
D27	PB5/
D30	PB9/

2.2.6

EVB 4 2*13

MCU

2.2.7

EVB 2

32.768KHz

8MHz

2

MCU

专	/	
Y1	PH0/XTAL_IN	8MHz
	PH1/XTAL_OUT	
Y2	PC15/XTAL32_IN	32.768KHz

2.2.12 QSPI

EVB 1 8MB QSPI FLASH W25Q64 QSPI

2.2.13 TF CARD

EVB 1 TF CARD TF CARD

TF CARD

专	/
J17	PC8/SDIO_D0
	PC9/SDIO_D1
	PC10/SDIO_D2
	PC11/SDIO_D3
	PC12/SDIO_CLK
	PD2/SDIO_CMD

2.2.14 SMART CARD

EVB 1 SMART CARD SMART CARD

SMART CARD

专	/
J20	PA0/RESET
	PA1/PWR_EN
	PA2/USART2_TX
	PA3/USART2_RX
	PD7/USART2_SCK
	PB1/CARD_DET

2.2.15 USB

EVB 2 Micro-USB J1 J14 5V0

J1 MCU

专			
J2	EVb	J1	
J15	EVb	J14	
J7	MCU	BOOT	
		USER	
J24	ADC	ADC12_IN10	
J25	ADC	3V3	

3.

MCU IDE IAR Keil MDK
MCU IDE <https://www.hdsc.com.cn>

🏠 > > 产品分类 > MCU > 通用类MCU

HC32F460PETB-LQFP100

产品特点	技术文档	开发工具	应用方案
华大开发板			
📄 EV-HC32F460-LQFP100设计文件.zip		zip 2020-09-18	📄
📄 EV-HC32F460-LQFP100硬件库文件.zip		zip 2020-09-18	📄
驱动库及样例			
📄 hc32f46x_ddl_Rev1.1.1.zip		zip 2020-09-18	📄
📄 hc32f46x_ddl_help_Rev1.1.1.zip		zip 2020-09-18	📄
📄 hc32f460_template_Rev1.0.3.zip		zip 2020-09-18	📄
IDE支持包			
📄 HC32F460_IDE_Rev1.0.5.zip		zip 2020-09-18	📄

3.1

-DDL

DDL

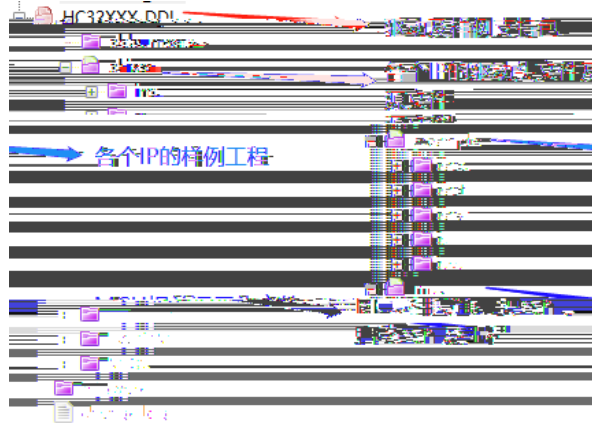

driver

IP API

example

IP IAR Keil
 IP
 EVB Demo

mcu

 MCU common IAR
 EWARM Keil MDK

middleware

三

3.2

-help

ddl_help API

3.3

-Template

Template

Keil				Keil
	<	>:\mcu\MDK*.FLM		Keil
>:\Keil\ARM\Flash\		Keil		<
*.FLM				

4.

4.1

	USB-UART	Win7	
Win10	Prolific	(http //www.prolific.com.tw)	PL2303HXD

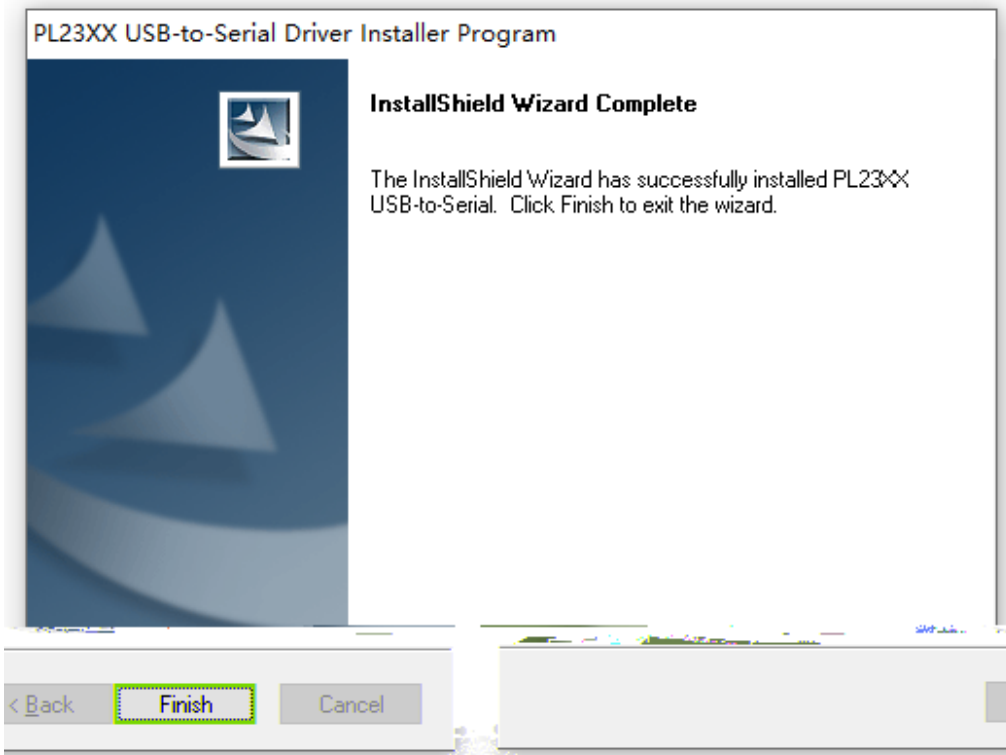
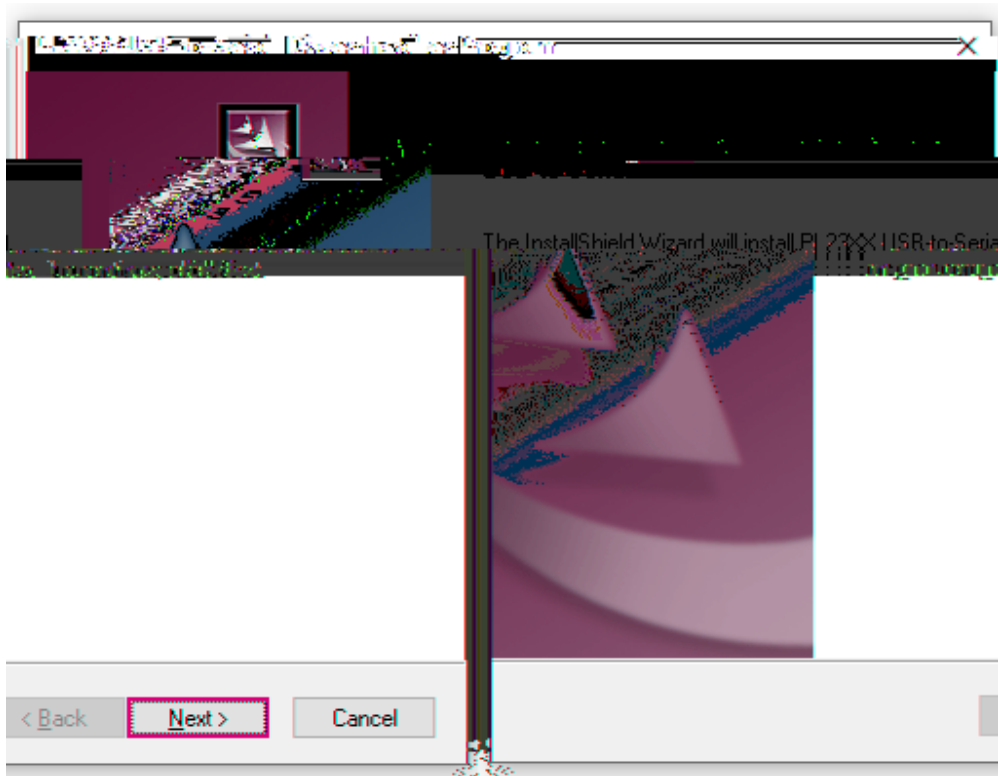

▼  端口 (COM 和 LPT)

 Prolific USB-to-Serial Comm Port (COM16)

4.2

HC32F460 MCU

UART

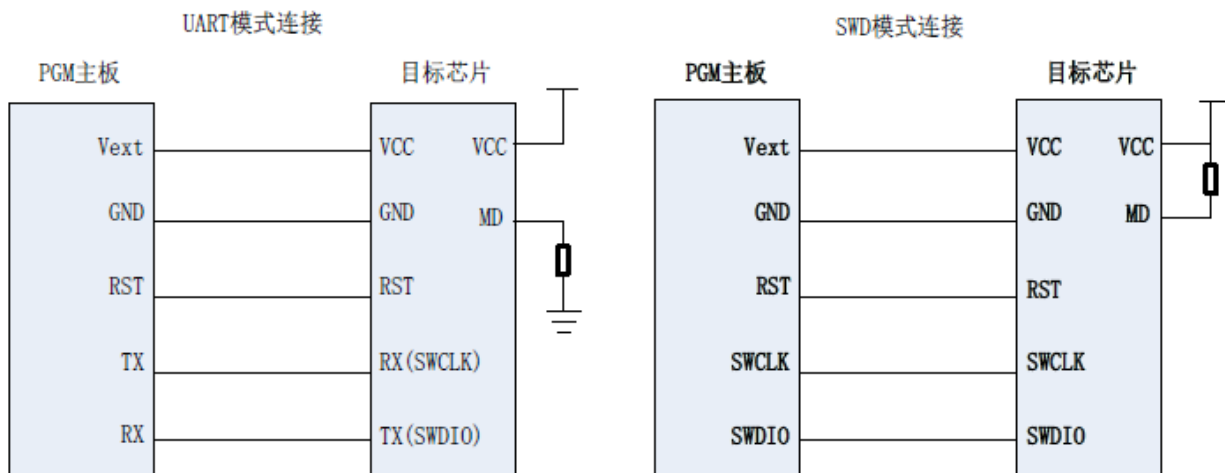
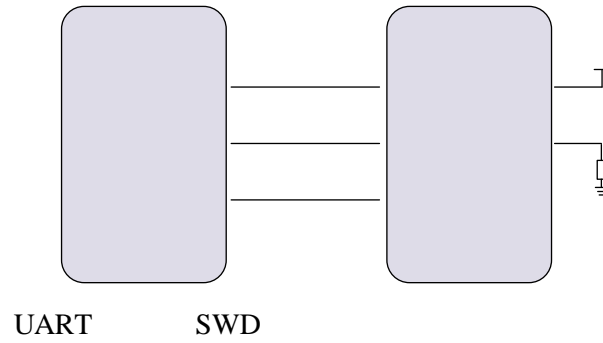





HC32F460PETB

产品分类 > MCU > 通用类MCU







HC32F460PETB-LQFP100

- 产品特点
- 技术文档
- 开发工具**
- 应用方案



华大开发板

 EV-HC32F460-LQFP100设计文件.zip	zip 2020-09-18	
 EV-HC32F460-LQFP100硬件库文件.zip	zip 2020-09-18	



驱动库及样例

 hc32f46x_ddl_Rev1.1.1.zip	zip 2020-09-18	
 hc32f46x_ddl_help_Rev1.1.1.zip	zip 2020-09-18	
 hc32f460_template_Rev1.0.3.zip	zip 2020-09-18	

IDE支持包

 HC32F460_IDE_Rev1.0.5.zip	zip 2020-09-18	
---	------------------	---

华大编程器

 ...	zip 2020-09-25	
---	------------------	---

5. &

2020/11/20	Rev1.0	



Email mcu@hdsc.com.cn

www.hdsc.com.cn

—

1867 A 10

201203

